

ONTARIO ENERGY BOARD

---

# DISTRIBUTED ENERGY RESOURCES CONNECTION PROCEDURES

Version 2 – January 27, 2025

(Originally Issued on March 22, 2022)



Ontario  
Energy  
Board

# Table of Contents

<b>1.</b>	<b>Purpose</b> .....	<b>3</b>
<b>2.</b>	<b>Definitions</b> .....	<b>3</b>
<b>3.</b>	<b>Distributed Energy Resources Connection Procedures Overview</b> .....	<b>4</b>
<b>4.</b>	<b>Preliminary Consultation</b> .....	<b>5</b>
	4.1 Description.....	5
	4.2 Restricted Feeder Lists .....	5
	4.3 Preliminary Consultation Information Request.....	5
	4.4 Preliminary Consultation Report.....	6
<b>5.</b>	<b>Connection Impact Assessment</b> .....	<b>7</b>
	5.1 Description.....	7
	5.2 Application forms .....	8
	5.3 Micro Generation Facility Connections .....	9
	5.4. Connection Application Processes for Small, Mid-Sized, and Large Generation Facility Projects.....	14
	5.5. CIA Screening Process .....	14
	5.6 CIA Process for Small, Medium, and Large Generation Facilities.....	18
	5.7 Simplified CIA Process.....	23
	5.8 CIA Process for Flexible Hosting Capacity Arrangements .....	23
	5.9 Connection Cost Estimates .....	23
<b>6.</b>	<b>Connection Cost Agreement</b> .....	<b>25</b>
	6.1. Connection Cost Agreement .....	25
	6.2 Connection Cost Responsibility (CCR).....	28
<b>7.</b>	<b>Build and Energization</b> .....	<b>28</b>
	7.1 Overall Build and Energization Process .....	28
	7.2 Commissioning .....	32
	7.3 Connection Agreement .....	32
	7.4 Project Completion.....	33
<b>8.</b>	<b>Glossary</b> .....	<b>34</b>
<b>9.</b>	<b>Appendices</b> .....	<b>36</b>

Appendix A - Sample Protection Philosophy for Battery Energy Storage System..... 37  
Appendix B - Sample Single Line Diagram ..... 42  
Appendix C - Standardized Form Templates..... 47  
Appendix D - DER Classification..... 48  
Appendix E - Simplified Connection Impact Assessment ..... 49  
Appendix F - Simplified Commissioning and Verification Template ..... 52

# Table of Figures

*Figure 1: Distributed Energy Resources Connection Process..... 4*  
*Figure 2: Micro Generation Facility Connection Process..... 10*  
*Figure 3: CIA Screening Process..... 16*  
*Figure 4: CIA Process for Small, Mid-sized, or Large Generation Facility ..... 20*  
*Figure 5: Connection Cost Agreement Process ..... 26*  
*Figure 6: Build and Energization Process ..... 29*  
*Figure 7: PCC vs PODC (Without Distributor-Owned Line Expansion) ..... 35*  
*Figure 8: PCC vs PODC (With New Distributor-Owned Line Expansion) ..... 35*

## 1. Purpose

The Distributed Energy Resources Connection Procedures (DERCP) document is a consolidation of the procedures, timing, workflows, and template forms issued by the Ontario Energy Board (OEB) to facilitate the communication and implementation of a standardized procedure for the connection of distributed energy resources (DERs) to distribution systems.

The provisions of the DERCP are given force by requirements of Chapters 3 and 6 of the Distribution System Code (DSC) as noted throughout. Compliance with the DSC is a condition of the OEB's Electricity Distributor Licence. Pursuant to the *Ontario Energy Board Act, 1998*, OEB codes, including the DSC, may incorporate by reference, in whole or in part, any standard, procedure or guideline. In case of any conflict between the DERCP and the Code, the provisions of the Code shall govern.

## 2. Definitions

All definitions in Section 1.2 of the DSC are adopted and apply in the DERCP. The most relevant definitions in the context of the DERCP are: emergency backup generation facility, exporting connection, non-exporting connection, restricted feeder, and system power.

For the purposes of the DERCP the following definitions also apply:

### **Applicant**

An applicant means a person who approaches a distributor and requests information for the purpose of connecting, or requests to connect a DER to the distributor's system.

### **Connection Impact Assessment (CIA)**

A connection impact assessment means a study performed by or on behalf of the distribution company to assess the impact of a proposed DER (generation or storage facility) connection on its system. The CIA will specify technical requirements for the connection.

### **Distributed Energy Resource (DER)**

Distributed Energy Resource (DER) means, for the purposes of the DERCP, an electricity source that is connected to a distribution system for the purpose of providing energy, typically through a connection on the customer-side of an ownership demarcation point. Sources generate electricity (e.g. generation facilities and energy storage facilities when discharging).

### 3. Distributed Energy Resources Connection Procedures Overview

The DERCP applies to the connection of a generating facility, including a storage facility, to a distribution system. Throughout the DERCP, the term “generating facility” includes energy storage facilities. All timelines specified in the DERCP refer to calendar days. When an energy storage facility is in discharge mode, it is treated the same as a generating facility. When an energy storage facility is in charging mode, it is treated the same as a load. The DERCP applies regardless of whether the connection is expected to be exporting energy to the grid or non-exporting as both types of generation facilities contribute to short circuit current through the connection under fault conditions. For emergency backup generation facilities, customers are referred to their respective distributor’s websites for information on connection requirements.

From the distributor’s perspective, the connection process can be broken into 4 main stages once an applicant approaches the distributor for a connection. The DERCP provides process flowcharts, information requirements and template forms regarding interaction between applicants and distributors for the 4 stages.

- a) **Preliminary Consultation**
  - Planning, information exchange, capacity check
- b) **Connection Impact Assessment**
  - Capacity allocation
  - Technical requirements for connection
  - Connection cost estimate
- c) **Connection Cost Agreement**
  - Project scope and cost
- d) **Build and Energization**
  - Connection work
  - Commissioning
  - Connection Agreement
  - Project completion



Figure 1: Distributed Energy Resources Connection Process

A distributor is required by Section 6.2.3 of the DSC to maintain a location on its website that serves as a centralized repository for all the information, forms and instructions, including information on applicable fees, necessary for an applicant to apply for connection to the distributor’s system.

## 4. Preliminary Consultation

### 4.1 Description

During the initial planning phase of a project, an applicant needs to know if there are any potential connection complexities or system limitations that could prevent connecting the project at a specific location on a distributor's distribution system. The DERCP provides template forms in Appendix C that a distributor must make available to an applicant pursuant to section 6.2.9 of the DSC. The applicant completes and submits a Preliminary Consultation Information Request (PCIR) form to the distributor. The distributor in turn responds with a Preliminary Consultation Report (PCR). A PCR is not required in order to apply for a CIA, however it contains connection-related details that can be helpful in completing the CIA application.

### 4.2 Restricted Feeder Lists

A distributor will, in accordance with the requirements of the DSC:

- a) Maintain a list<sup>1</sup> of feeders that it owns that have no additional short circuit capacity to accommodate a DER connection.
- b) A feeder should be included on the list whether the constraint is within the distributor's system or caused by limitations upstream in the host distributor or transmitter's system.
- c) Update the list if the system changes or at least every 3 months.

When the distributor removes a feeder from the list of restricted feeders, the distributor shall a) notify the public of this change on its website; and b) notify by email those customers who have expressed an interest in receiving information on the status of the feeder. The notification shall be given as soon as possible and at least one month prior to accepting new applications for the connection of DERs to the feeder.

### 4.3 Preliminary Consultation Information Request

The PCIR form gathers basic information on the proposed project, including applicant information, project nameplate and type, proposed fuel/energy type, site information (including information on existing DER(s) at the same site), and other information. The DERCP includes templated forms to standardize the means by which this information is to be collected. The template form is included in Appendix C to the DERCP.

- 4.3.1** Where the distributor needs to add to the template PCIR form in response to unique characteristics of its system or operational needs, the distributor will advise the OEB of the changes.

---

<sup>1</sup> A distributor may use an interactive tool to allow applicants to check feeder capacity for a restricted feeder.

- 4.3.2** A distributor may establish a web-based interface for the purpose of collecting this information, provided the web-based interface is consistent with Appendix A or is amended in accordance with section 4.3.1.

#### **4.4 Preliminary Consultation Report**

The PCR is provided by the distributor to the applicant and identifies the feasibility and the complexity level of a connection based on the information provided in the PCIR and the distributor's knowledge of available capacity at the proposed point of connection. However, capacity is only reserved upon completion of a successful CIA.

The Preliminary Consultation Report will provide a preliminary assessment of connection complexity including information on:

- i. System constraints
- ii. Anticipated impact assessments required  
The PCR will identify what connection studies will be required at the CIA application stage. Depending on the size and location of the project, these may include multiple studies: the distributor, and if applicable: the host distributor, the transmitter, and possibly a System Impact Assessment from the IESO.
- iii. Distribution system infrastructure
- iv. Protection, monitoring, metering, and telecom
- v. LDC-specific criteria
- vi. LDC overall assessment of connection feasibility

The distributor must respond to a PCIR within 15 days of receipt of a PCIR as per Section 6.2.9.1 of the DSC.

If the PCR identifies the overall assessment is "Conditional Pass: Capacity may be available, pending a Connection Impact Assessment" or 'Conditional Pass: Capacity may be available, pending a Connection Impact Assessment and adherence to the Flexible Hosting Capacity Arrangement', it will provide information that the applicant will need to prepare for a CIA application. Any other information that the distributor considers helpful to the applicant in deciding whether to proceed to the next stage of connection, is to be included in the additional comments section of the PCR.

It is important to remember that the PCR is a snapshot in time and does not reserve capacity for a project.

## 5. Connection Impact Assessment

### 5.1 Description

The next stage for the connection of a DER is the CIA. This is a study prepared by the distributor that assesses the steady state and transient reliability and stability impacts of the project at the specific location on the distribution system. The information requirements at this stage are more substantial than the preliminary consultation phase; nonetheless, applicants are cautioned that completion of a CIA does not constitute approval of the protection philosophy and single line diagram (SLD) by the distributor. The protection philosophy and SLD will be subject to distributor review after the CIA has been issued.

Depending on the size of the project and its location within the distribution system, an additional CIA by a host distributor and/or transmitter, and/or a System Impact Assessment by the IESO may also be necessary to assess upstream system impacts. The PCR will identify, for the location specified in the PCIR, the additional studies required. Table 1 outlines an anticipated additional studies required based on DER classification.

*Table 1: Connection Classifications for Processing*

DER Classification	Rating	Potential Studies:
Micro	≤ 10 kW	None
Small	(a) ≤ 500 kW connected on distribution system voltage < 15 kV (b) ≤ 1 MW connected on distribution system voltage ≥ 15 kV	1. Distributor 2. Host Distributor (if applicable)
Mid-Sized	(a) ≤10 MW but > 500 kW connected on distribution system voltage < 15 kV (b) > 1 MW but ≤ 10 MW connected on distribution system voltage ≥ 15 kV	1. Distributor 2. Host Distributor (if applicable) 3. Transmitter
Large	> 10 MW	1. Distributor 2. Host Distributor (if applicable) 3. Transmitter 4. IESO System Impact Assessment

In determining the size of a DER facility for the purpose of DER classification, the distributor shall accept statically derated capacity, achieved through configured power rating control, of a DER unit or inverter instead of nameplate rated capacity if it has been



derated at the factory. If the DER unit or inverter has been derated in the field by either the installer or manufacturer, the distributor shall accept the derated capacity if the following conditions are met:

1. The derated capacity is clearly indicated on the equipment, adjacent to the nameplate,
2. Proper labeling must specify site-specific power and current values,
3. Documentation provided by the inverter manufacturer must state the maximum continuous derated output current in amperes. Alternatively, the programmed limit can be demonstrated to the distributor's satisfaction, such as through certification from a licensed electrician, and
4. A restricted access protocol must be in place to prevent unauthorized capacity changes.

The applicant will also need to comply with other industry requirements with respect to derated capacity.

Appendix D provides further guidance on the determination of DER classification.

In response to a CIA application and where the distributor has determined that there is available capacity to connect the proposed project:

- 5.1.1.** The distributor will provide the applicant with the technical and non-technical requirements for connection to the distributor's system.
- 5.1.2.** The distributor will provide an estimate of the cost to facilitate the connection. Section 5.9 has more information on connection cost estimates.
- 5.1.3.** The distributor will reserve capacity on its system for the proposed project in accordance with Section 6.2.4.1 of the DSC.
- 5.1.4.** The distributor will provide an offer to connect in accordance with the requirements of the DSC.

## **5.2 Application forms**

In accordance with DSC sections 6.2.5 and 6.2.11, the distributor must make the connection agreement for micro generation facilities and the CIA application form for all other generation facilities available on its website and in hard copy at its offices. It is preferable for applicants to be able to fill in and submit these forms electronically through email or the distributor's website. To facilitate timely and near concurrent processing of the application, applicants are encouraged to provide payment for all required studies with the application (i.e. study payments for the distributor, host distributor, transmitter and IESO, if required). Distributors will require payment before commencing studies. The distributor will identify on its website and in the application package the relevant study fee charges.

## **Micro Generation Facility**

To apply for a connection of a micro generation facility, an applicant will submit to the distributor a copy of the Micro-Embedded Generation Facility Agreement, in the form provided in Appendix E of the DSC. The applicant will provide the relevant information on the connection agreement and submit it to the distributor. If requested by the distributor, the applicant shall also provide an SLD and generator specification and connection information as required. The distributor may establish and use its own intake form for processing micro generation facility connection applications, but any agreement between the distributor and the applicant for the connection of the micro generation facility must be in the form provided in Appendix E of the DSC. The distributor will assess the project and, if approved for connection, sign the connection agreement, and proceed with the connection.

## **Small / Mid-sized / Large Generation Facility**

For all other categories of projects, distributors must use the CIA Application template form provided by the OEB in Appendix B, unless the project qualifies for a simplified CIA as set out in Appendix E. The expectation of the OEB is that the distributor will only need to add its contact information to the template prior to deploying the form. If unique characteristics of a distributor's system require the distributor to make revisions to the template form, beyond the designated distributor-specific sections, then the revised form must be filed with the OEB.

## **5.3 Micro Generation Facility Connections**

### **5.3.1 Micro Generation Facility Connection Processes**

Micro generation facilities are equal to or less than 10 kW and are considered to pose a relatively low connection risk to the distribution system compared to larger generation facilities. The distributor (in accordance with Section 6.2.6 of the DSC) and applicant are expected to follow the process flowchart in Figure 2 and steps outlined below.

## Connection Process: Micro Generation Facility

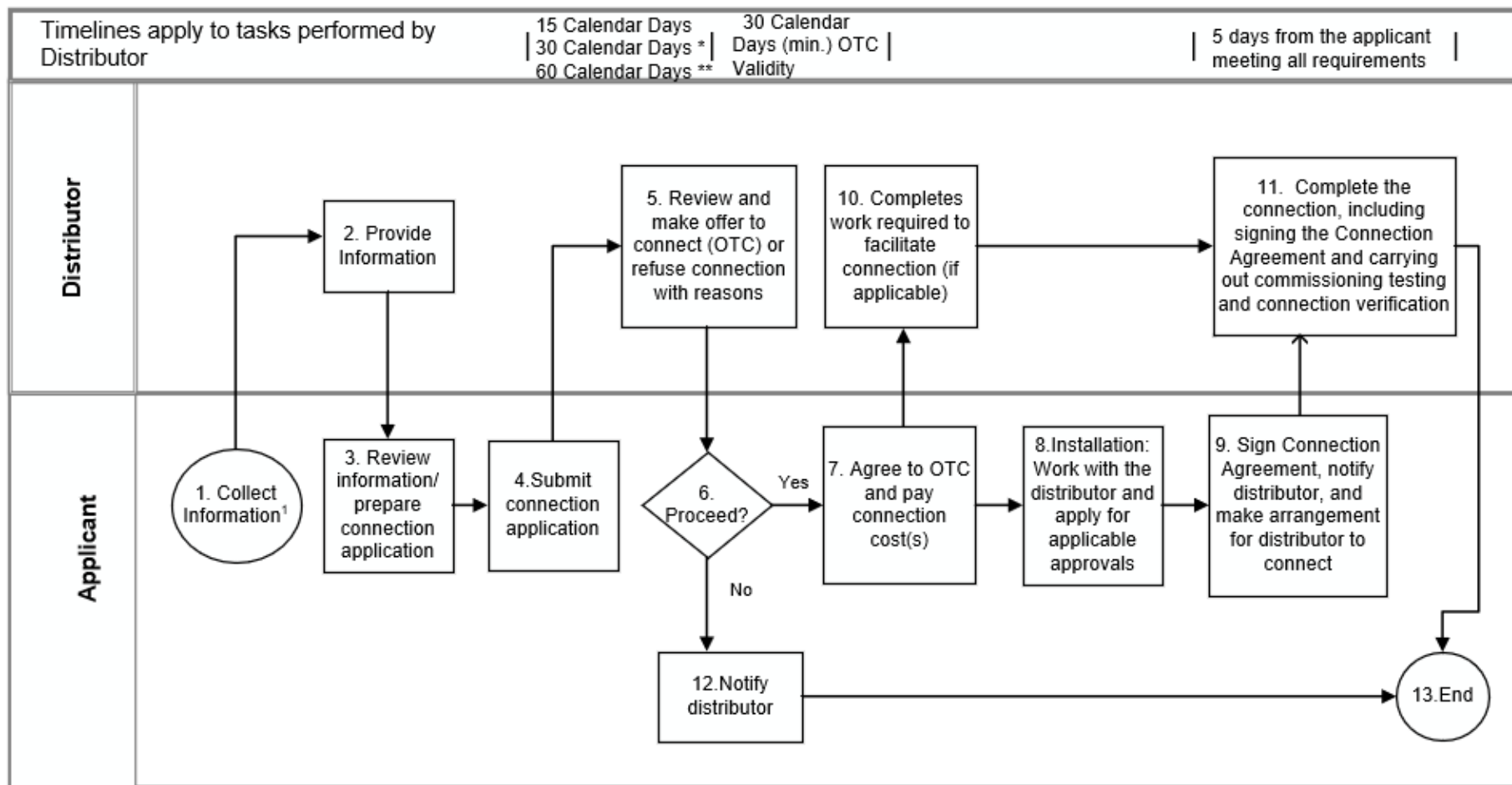

\* If at existing connection and site assessment needed    \*\* If not located at existing customer connection  
 1 Check distributor webpage for information on process, forms and other helpful info, including how to apply.

Figure 2: Micro Generation Facility Connection Process

Step 1	The applicant proposing to connect a micro generation facility checks the distributor’s DER webpage for information on processes, forms and other helpful information, including how to apply. The applicant can also contact the distributor and the Electric Safety Authority (ESA) to obtain more information on connection process and requirements.
Step 2	The distributor makes the information on connection process available to the applicant in a timely manner. The information package includes the description of the connection process approvals needed by the distributor for connection, technical requirements including metering, contractual requirements (Micro-Embedded Generation Facility Connection Agreement), and application forms.
Step 3	<p>The applicant reviews relevant information and prepares a connection application that includes:</p> <ul style="list-style-type: none"> <li>• an installation plan, including the size, type of generation (e.g. net metering and non-exporting) facility; and</li> <li>• a project plan.</li> </ul>
Step 4	The applicant submits a connection application to the distributor for its review.
Step 5	<p>Within the prescribed timeline, which varies based on the facility location, the distributor shall either provide the applicant with an offer to connect (OTC) or a refusal to connect, including reasons for the decision, as outlined in sections 5.3.2, 5.3.4, and 5.3.5 below.</p> <p>The distributor’s review of an application submitted for the connection of a micro generation facility will include:</p> <ul style="list-style-type: none"> <li>• typical requirement for new meter;</li> <li>• check for service upgrade requirement;</li> <li>• check for significant amount of other generation on feeder;</li> <li>• response to the applicant with an offer to connect or refusal; and</li> <li>• response to applicant with requirements specific to the connection (typically requirements for metering) and costs, timing to implement, etc.</li> </ul>
Step 6	The applicant decides whether to proceed with the connection. If so, proceed to step 7. If not, proceed to step 12.
Step 7	The applicant must indicate its intention to connect. Within the validity period of the OTC, which shall be at least 30 days, the applicant

	accepts the OTC and pays the required connection cost(s).
Step 8	<p>During the installation phase, the applicant should work closely with the distributor, the ESA, and any other organizations from which work, inspections, approvals, or licences are required to prevent delays.</p> <p>The activities will be planned in coordination with project milestones, and it is up to the applicant to initiate actions at the required times.</p>
Step 9	The applicant reviews and signs the connection agreement, notifies the distributor, and makes arrangement for the distributor to connect.
Step 10	The distributor completes any work required to facilitate the connection to the distribution system (if applicable).
Step 11	Subject to the provisions of section 6.2.7 of the DSC, the distributor works with the applicant to complete the connection, including signing the connection agreement and carrying out any commissioning testing and connection verification.
Step 12	If the applicant decides not to proceed with the connection (step 6), the applicant notifies the distributor of the applicant's decision not to proceed with the connection process and then proceeds to step 13.
Step 13	The connection process ends.

**5.3.2.** If the proposed facility is located at an existing customer connection and does not require a site assessment, the distributor shall make an offer to connect within 15 days of receiving a completed application or provide reasons for refusing to connect.

**5.3.3.** The distributor shall not charge the applicant to prepare the offer to connect outlined in section 5.3.2 above.

**5.3.4.** If the proposed facility is located at an existing customer connection and requires a site assessment, the distributor shall make an offer to connect within 30 days of receiving a completed application or provide reasons for refusing to connect.

**5.3.5.** If the proposed facility is not located at an existing customer connection, the distributor shall make the offer to connect within 60 days of receiving a completed application or provide reasons for its refusal.

- 5.3.6.** In all cases, the distributor shall give the applicant at least 30 days to accept the offer to connect and the distributor shall not revoke the offer to connect until this time period has expired.
- 5.3.7.** If a site assessment is needed, the distributor may charge a \$500 connection deposit for preparing the offer to connect, which shall be payable in the form of cash, cheque, electronic funds transfer, letter of credit from a bank, or surety bond.
- 5.3.8.** If the distributor refuses the connection after a site visit, it shall return the deposit within 30 days.
- 5.3.9.** If the applicant does not accept the offer or withdraws its application, the distributor will keep the deposit.
- 5.3.10.** If actual connection costs are less than the deposit, the distributor shall refund the difference when the connection is completed and in service.
- 5.3.11.** Interest shall accrue monthly on connection deposits made by way of cash or cash equivalents commencing on receipt of the total deposit required by the distributor. The interest rate shall be at the Prime Business Rate as published on the Bank of Canada website less 2 percent, updated quarterly. Refunds, in whole or part, of deposits made in cash or cash equivalents shall include interest on the refunded amount from the date of receipt.
- 5.3.12.** An applicant must notify the distributor that it has satisfied all applicable service conditions and received all necessary approvals including confirmation of issuance of the authorization to connect from the ESA.
- 5.3.13.** The applicant must enter into a Connection Agreement and pay the required connection costs, including costs for any necessary new or modified metering.
- 5.3.14.** Once these conditions have been satisfied, the distributor shall connect the applicant's micro generation facility to its distribution system within 5 business days, or at such later date as agreed to by the DER applicant and the distributor.
- 5.3.15.** The distributor must meet the five-day requirement for connection 90 percent of the time on a yearly basis.

#### 5.4. Connection Application Processes for Small, Mid-Sized, and Large Generation Facility Projects

The connection application processes for small, mid-sized, and large generation facilities are similar, with the differences primarily being the number and complexity of connection impact assessments required which will vary on a project to project basis and depend on the size of the project and the connection point to the system. Unlike the micro generation facility process, the connection process for small, mid-sized, and large generation facilities includes a common screening process on application intake.

#### 5.5. CIA Screening Process

CIA applications are subject to a review for completeness, i.e. a screening process. The screening process is intended to provide feedback to the applicant early in the process on any deficiencies in their submission that would prevent a distributor from proceeding with a review. Upon submission of an application, the distributor confirms if the application is substantially complete. A substantially complete application is a submission in which there is sufficient information provided for the distributor to process the application and complete the CIA. To aid an applicant in determining the information requirements that a distributor would typically deem as being sufficient information, a sample application package has been provided in the Appendix C(vii).

The sample application package includes:

- Completed application
- Single line diagram sample
- Protection philosophy sample
- Submission checklist

In order to facilitate timely processing of applications, payment<sup>2</sup> for the applicable studies should be included with the submission when possible. The fees for required studies and assessments should be identified on the distributor's website and in the PCR.

If the application is incomplete, the distributor will return the incomplete part of the application package to the applicant with a deficiency notification identifying the error and omissions in the application. Upon receipt of a deficiency notification, an applicant should review and correct the application and resubmit the revised application within 14 days. If the application is not returned in 14 days, the application may lose its position in the processing queue.

Upon receipt of a revised CIA application, the distributor must review the application within 7 days to determine if there is sufficient information for the distributor to process the application. If there is sufficient information, the

---

<sup>2</sup> Distributors are to identify required study cost in the Preliminary Consultation Report.

submission is deemed substantially complete, and the distributor will reconfirm that the distribution and transmission capacity that was available at the preliminary consultation stage remains available. Please note that capacity is not reserved until the CIA is completed. If capacity is available, the distributor will notify the applicant and proceed to perform a CIA. The date the submission is deemed substantially complete starts the timed-day window for the distributor to send the completed CIA to the applicant.

The process flowchart for determining the status of an application using the screening process is outlined in Figure 3. The corresponding procedure steps for the distributor and applicant to follow are outlined below the flowchart.



## CIA Screening Process

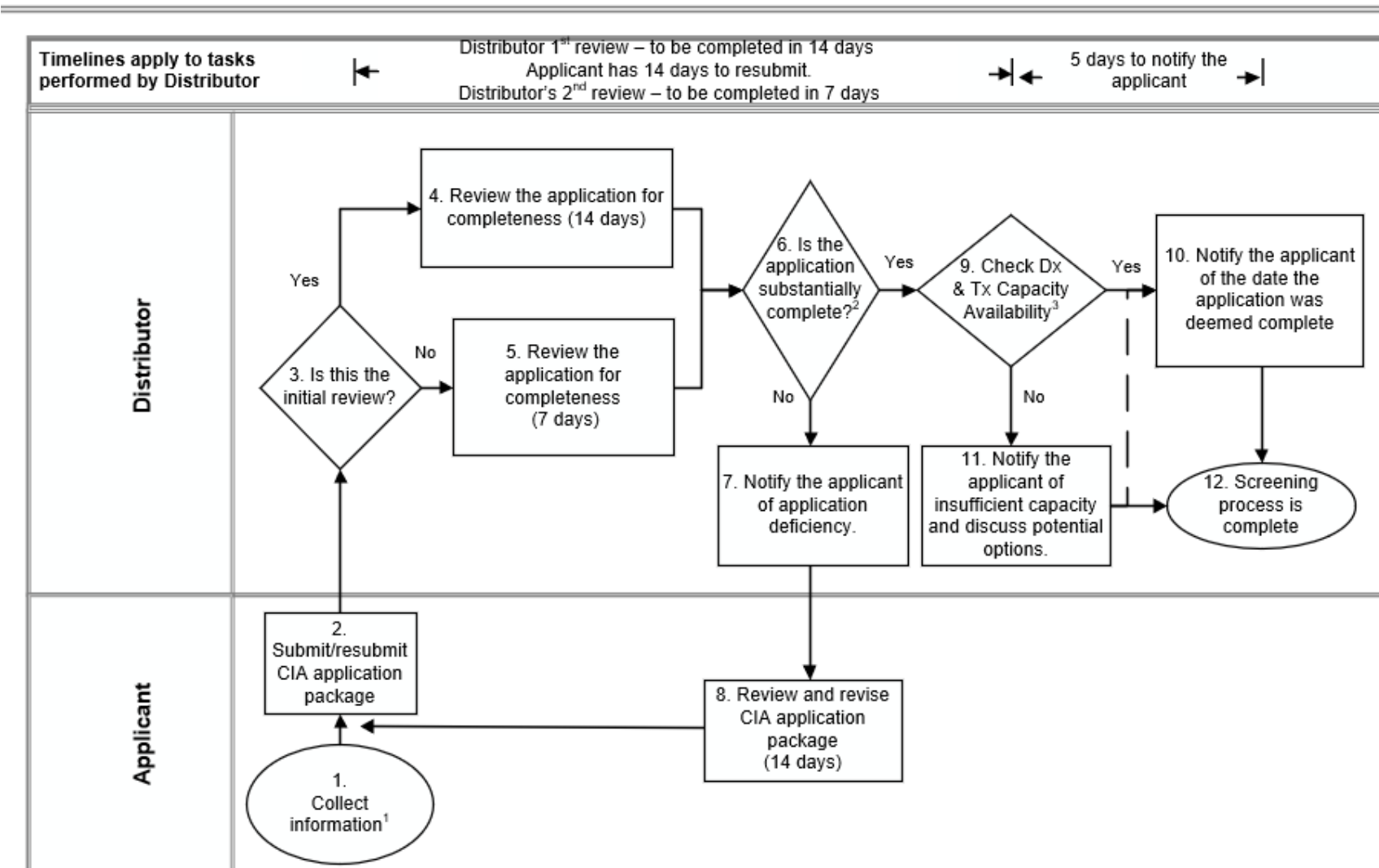

<sup>1</sup> Submitting a Preliminary Consultation Information Request (PCIR) prior to CIA application will help gather potential connection complexity information before investing in a CIA.

<sup>2</sup> A CIA application is complete if the information it contains is sufficient to allow a distributor to complete a CIA.

<sup>3</sup> A secondary check to address changes between the preliminary consultation and the CIA application.

Figure 3: CIA Screening Process

Step 1	The applicant begins the process by collecting any needed information. The applicant can submit a PCIR prior to a CIA application to gather potential connection complexity information specific to the generation facility.
Step 2	The applicant submits the completed CIA application package, including completed application form, payment for required studies, attachments, application checklist, and the PCR (if available).
Step 3	The distributor determines if this is the initial application submission or a revised application submission. If it is the initial submission, proceed to step 4. If it is a revised submission, proceed to step 5.
Step 4	For initial application submission, the distributor reviews the application to determine whether it is missing any required information. A review must be completed within 14 days.
Step 5	For revised application submission, the distributor reviews the revised application to determine whether it is missing any required information. A review must be completed within 7 days.
Step 6	For the completeness check outlined in steps 4 and 5, the distributor reviews the application to determine if the information the applicant provided is sufficient to allow the distributor to complete a CIA. If the distributor deems the application incomplete, proceed to step 7. If the distributor deems the application complete, proceed to step 9.
Step 7	For submissions that are not substantially complete, the distributor will notify the applicant of the application deficiencies via email or letter (if the applicant's email is not provided). The deficiency notification shall identify any errors and omissions in the application that would prevent the distributor from proceeding with the CIA. The notification shall outline the available remedies required to have the application deemed substantially complete.
Step 8	On receipt of a deficiency notification, an applicant should review and revise the application to address the deficiencies and resubmit the application. The process allows 14 days for the applicant to resubmit a revised application. If the applicant does not return the revised application within 14 days, it may be treated as a new application once it is resubmitted.
Step 9	For submissions that are deemed substantially complete, the distributor will reconfirm distribution and transmission capacity availability. This is a secondary check to address changes between

	the pre-consultation phase and the CIA application. The distributor may carry out a capacity check before the application completeness review. If capacity is available, proceed to step 10. If capacity is not available, proceed to step 11.
Step 10	The distributor notifies the applicant of within 5 calendar days of when the application is deemed substantially complete. The date the application is deemed substantially complete starts the timed-day window for the distributor to send the completed CIA to the applicant.
Step 11	If capacity is not available, the distributor will notify the applicant that capacity is not available to support the connection and may offer a flexible hosting capacity arrangement if the distributor has this option available. If the distributor and the applicant agree to explore a flexible hosting capacity arrangement, proceed to step 10. If not, process to step 12.
Step 12	The screening process is complete.

### 5.6 CIA Process for Small, Medium, and Large Generation Facilities

The next step in the connection process is the completion of the CIA. The overall CIA timelines are as follows:

For small generation facilities the distributor shall provide an applicant proposing to connect with its assessment of the impact of the proposed generation facility, a detailed cost estimate of the proposed connection and an offer to connect within:

- a) 60 days of the receipt of the complete application where no distribution system reinforcement or expansion is required; and
- b) 90 days of the receipt of the complete application where a distribution system reinforcement or expansion is required.

For mid-sized and large generation facilities, after receipt of a complete CIA application, a distributor shall respond with its CIA:

- a) within 60 days for a mid-sized generation facility;
- b) within 90 days for a large generation facility;
- c) within 75 days for a mid-sized generation facility when a host distributor/transmitter CIA is also needed; and
- d) within 105 days for a large generation facility when a host distributor/transmitter CIA is also needed.

The distributor must ensure that only 15 days are added to the overall CIA timeline for mid-sized and large projects when an upstream assessment is required.

The flowchart in Figure 4 describes the process for performing the CIA. The corresponding procedure steps for the distributor and applicant are outlined below the flowchart.

### CIA Process: Small, Mid-sized, or Large Generation Facility

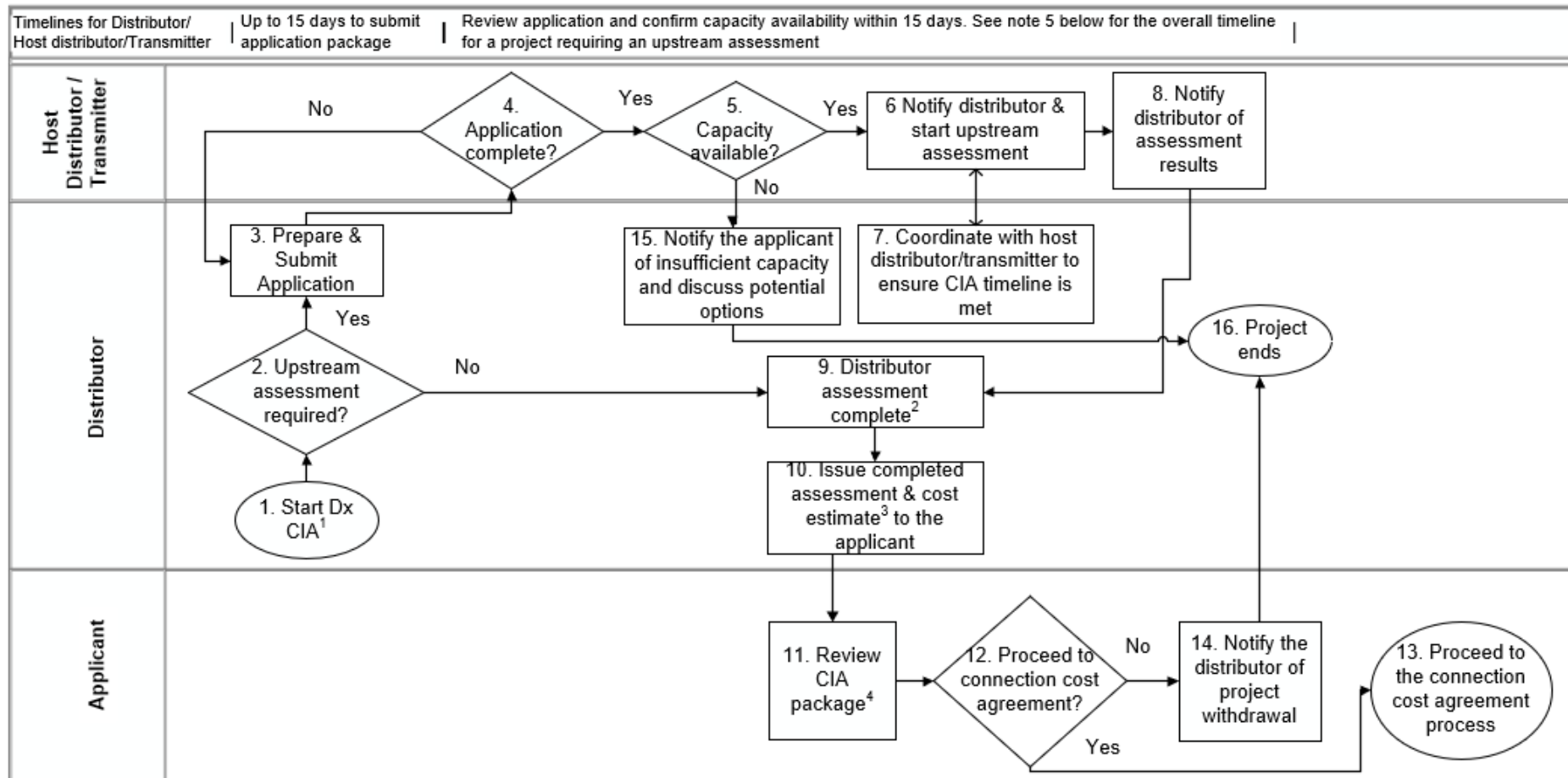

<sup>1</sup> Refer to CIA Screening flowchart for prior process steps; <sup>2</sup> Distributor consolidates finalized assessments  
<sup>3</sup> For mid-sized and large generation facility applications, the applicant may elect to obtain a detailed cost estimate which is a separate process that may require a new agreement between the applicant and the distributor, as well as associated fees; <sup>4</sup> The applicant to see CIA expiration terms and conditions  
<sup>5</sup> Overall CIA timeline for a project requires an upstream assessment: 60 days (Small DER – no system reinforcement/expansion)/ 90 days (Small DER – with system reinforcement/expansion)/ 75 days (Mid-sized DER) / 105 days (Large DER).

Figure 4: CIA Process for Small, Mid-sized, or Large Generation Facility

Step 1	The distributor initiates the distribution CIA when the CIA application is deemed substantially complete and gathers required information.
Step 2	The distributor determines if an upstream assessment from a host distributor/transmitter is required. If so, proceed to step 3. If not, proceed to step 9.
Step 3	If an upstream assessment is required, the distributor submits the completed CIA application package to the host distributor/transmitter, including completed application form, payment for required studies, attachments, and application checklist. The distributor must submit a completed application as soon as possible and no later than 15 days after starting the downstream CIA to ensure there is adequate time for the host distributor/transmitter to carry out upstream assessment(s) and to consolidate upstream assessment results into the distributor’s CIA. The distributor must include information on the expected timeline for the host distributor CIA in its application, in accordance with the project classification and the date the CIA application is deemed substantially complete in Step 1.
Step 4	The host distributor/transmitter reviews the application and determines if the application is complete. If additional information or changes to the application is/are needed, the host distributor/transmitter must inform the distributor as soon as possible, and no later than 15 days. This ensures there is sufficient time for the distributor to submit the revised application package and for the upstream assessment to be completed concurrently with the distributor’s CIA.
Step 5	The host distributor/transmitter confirms there is capacity for the connection. This check can take place again during the CIA process. If there is capacity available, proceed to step 6. If not, notify the distributor there is insufficient capacity and discuss the feasibility of a flexible hosting capacity arrangement.
Step 6	If the application is complete and capacity is available, the host distributor/transmitter notifies distributor and begins the upstream assessment.
Step 7	<p>Distributor coordinates with the host distributor/transmitter to ensure the host distributor/transmitter sends the upstream assessment in time for the distributor to complete the distribution CIA within the prescribed CIA timeline.</p> <p>The overall CIA timeline for a project requires an upstream assessment based on the size of the proposed DER:</p>

	<ul style="list-style-type: none"> <li>• Small DER:             <ul style="list-style-type: none"> <li>○ 60 days (without system reinforcement/expansion)</li> <li>○ 90 days (with system reinforcement/expansion)</li> </ul> </li> <li>• Mid-sized DER: 75 days</li> <li>• Large DER: 105 days</li> </ul>
Step 8	The host distributor/transmitter notifies distributor of assessment results.
Step 9	Upon receiving upstream assessment results, the distributor completes its CIA.
Step 10	The distributor issues a completed CIA and cost estimate to the applicant. For mid-sized and large generation facility applications, the applicant may elect to obtain a detailed cost estimate which is a separate process that may require a new agreement between the applicant and the distributor, as well as associated fees.
Step 11	The applicant will review the CIA package and signs the connection cost agreement within a prescribed timeline, in accordance with the terms and conditions regarding the expiration of the capacity allocation.
Step 12	The applicant decides whether to proceed to the connection cost agreement to move forward with the connection process. If so, proceed to step 13. If not, proceed to step 15.
Step 13	The applicant proceeds to the connection cost agreement process.
Step 14	If the applicant decides not to proceed, notify the distributor in writing of project withdrawal.
Step 15	Upon receiving the notification from the host distributor/transmitter that there is insufficient capacity in Step 5, the distributor notifies the applicant. The distributor identifies the potential for entering into a flexible hosting capacity arrangement.
Step 16	Project ends due to insufficient capacity, or the applicant's decision not to proceed to the connection cost agreement process.

## 5.7 Simplified CIA Process

A distributor shall offer a simplified CIA process to small DERs that meet distributor-specific criteria, such as, but not limited to, a nameplate rated capacity threshold, and receive a confirmation from the distributor.

The simplified CIA process is expected to reduce assessment costs and timelines for a subset of small DERs.

Appendix E outlines the provisions for simplified CIA process including: eligibility, timelines, fees, potential outcomes, and processes.

## 5.8 CIA Process for Flexible Hosting Capacity Arrangements

A distributor may offer a flexible hosting capacity arrangement to a proposed DER when the entire requested capacity is not available in the normal capacity allocation process, and when it is cost effective and technically feasible to proceed. Under a flexible hosting arrangement, the proposed DER's output or operation can be varied according to system operating conditions as agreed to by the distributor and DER customer. This arrangement will enable a distributor to optimize the capacity available on its distribution system and support greater DER adoption, through use of technologies such as a DER management systems (DERMs).

In the case of flexible hosting capacity arrangements, the distributor is not required to adhere to the prescribed timelines for CIA, as mentioned under section 5.6, and capacity allocation timeline or CIA validation timeline, as mentioned under process step 1 of Figure 5. However, the distributor is expected to follow, as closely as possible, the processes set out above in the flow charts. In setting out to offer flexible hosting arrangements, a distributor will establish reasonable timelines for CIA and capacity allocation to ensure timely connections and avoid creating new connection barriers to other prospective DER customers. The distributor will aim to provide the technical requirements and estimated cost for the proposed connections as soon as possible without affecting the timelines for other connections that are ahead of the applicant.

The distributor must inform prospective DER customers and include information in the DER connection section of its website about whether they offer flexible hosting capacity arrangements. The distributor will also confirm the feasibility through the preliminary consultation and CIA processes.

## 5.9 Connection Cost Estimates

When a distributor provides the applicant with the technical requirements for the proposed connection as a result of a CIA, the distributor shall also provide a cost estimate for the connection. At this stage, the cost is usually based on typical pricing, with the distributor indicating the anticipated level of uncertainty in the estimate.



### 5.9.1 Cost estimate timeline extension for a mid-sized or large generation facility

During the CIA process, when a distributor anticipates needing additional time to carry out a cost estimate for a mid-sized or large generation facility, it may assess whether the project meets the criteria below for a timeline extension. Upon confirmation, the distributor must document the rationale for the extension, detailing how the criteria are met, and inform the applicant of the need for extra time, including the rationale for the extension and the revised timeline for the cost estimate. This extension does not change the prescribed timeline the distributor must adhere to when providing the applicant with the technical requirements for connecting to the distributor's system.

The following criteria must be used by the distributor to assess whether a timeline extension can be applied to a specific project:

1. In comparison to historical projects, the project must include one or more connection work items that are atypical or complex where the distributor:
  - a) needs to carry out additional technical and cost evaluation of various options to determine the most suitable and cost-effective solution for the applicant, or
  - b) cannot obtain the estimated cost from potential vendors or through information sharing with other distributors in time, or
  - c) must carry out additional studies to implement a complex operational arrangement requested by the applicant such as islanding mode to enable microgrid configuration

and

2. The additional days the distributor plans to take must lead to a meaningful improvement in the accuracy of the cost estimate. If the potential cost difference is not material, the distributor should provide the cost estimate simultaneously with the technical requirements for connection.

A distributor can take up to 30 days after issuing the CIA with the technical requirements for a connection, to complete the cost estimate for a mid-sized or large project that meets both criteria listed above. The distributor must indicate on its website that a project that meets the criteria may require additional time for the cost estimate.

### 5.9.2 Option to Request a More Detailed Cost Estimate

Upon receipt of the CIA, an applicant for a mid-sized or large generation facility has the option to request a more detailed cost estimate prior to entering into a Connection Cost Agreement.

To obtain a detailed estimate, the applicant must make a written request for the estimate. If necessary, the distributor and applicant may enter into an agreement for the preparation of the detailed cost estimate, and the applicant

may be responsible for paying the distributor's costs for preparation of the detailed cost estimate. Within 10 days of receiving the payment from the applicant for a mid-sized or large DER, the distributor shall inform the host distributor/transmitter that it is preparing an estimate. For a small DER, the distributor shall only inform the host distributor/transmitter, within 10 days of receiving payment, if it believes their system may be impacted by the proposed DER. The distributor shall provide the applicant with the detailed cost estimate and an offer to connect by the later of 90 days after the receipt of payment from the applicant and 30 days after the receipt of comments from a host distributor/transmitter.

When the proposed connection is under a flexible hosting capacity arrangement, the distributor will make best effort to follow the timelines mentioned above.

## 6. Connection Cost Agreement

Once the distributor and transmitter or host distributor have completed their respective CIAs and cost estimates, the process moves to the Connection Cost Agreement phase and then moves to the Build & Energization phase which requires a Connection Agreement.

### 6.1. Connection Cost Agreement

The Connection Cost Agreement (CCA) sets out the scope of work and the associated cost the distributor will recover from the applicant to connect the project to the distribution system. If the connection affects a host distributor's distribution system or the transmission system, the host distributor will complete a CIA and require a CCA while the transmitter will complete a transmitter study and require a Connection and Cost Recovery Agreement (CCRA). In cases where a CCRA is required, the distributor will include the costs of any transmission work in its own CCA. It is the distributor's responsibility to contract with and pay the transmitter and then recover those costs from the applicant. The OEB does not prescribe specific forms for CCA and CCRA.

Figure 5 outlines the interaction between the applicant, distributor, and host distributor/transmitter when multiple assessments and agreements are involved. The corresponding process steps are provided below the figure.

## Connection Cost Agreement

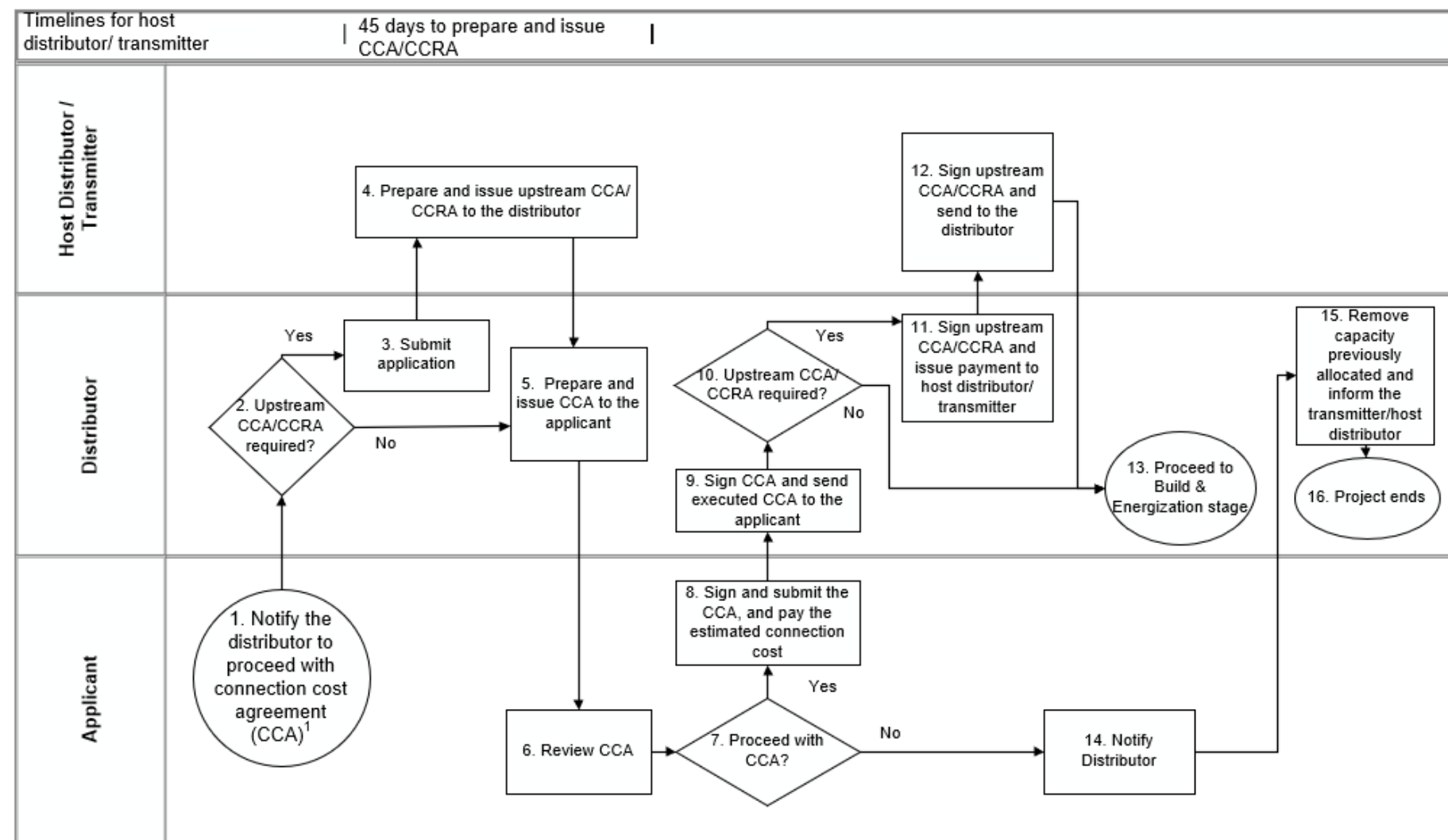

<sup>1</sup> If the CCA is not signed within 6 months for small and mid-sized generation facilities and 9 months or 17 months for large generation facilities, the capacity allocation will be removed and the CIA will become invalid. The applicant may need to complete a CCA application form.

Figure 5: Connection Cost Agreement Process

Step 1	<p>The applicant notifies the distributor that it wishes to proceed with the CCA process. To ensure the capacity allocation is not lost and the CIA remains valid, the applicant should initiate the CCA process promptly. This allows sufficient time for all parties to prepare and sign the CCA before the prescribed deadlines. The CCA must be signed within:</p> <ul style="list-style-type: none"> <li>- 6 months for small and mid-sized generation facilities</li> <li>- 9 months for large generation facilities if a transmission system impact assessment is required; or</li> <li>- 17 months for large generation facilities if transmission upgrades are required.</li> </ul> <p>from the date the applicant receives the technical requirements for the connection under the CIA process.</p>
Step 2	<p>The distributor determines whether an upstream CCA from a host distributor or a CCRA from a transmitter is needed. If upstream cost agreement is needed, proceed to step 3. If not, proceed to step 5.</p>
Step 3	<p>The distributor submits upstream CCA/CCRA application to host distributor/transmitter and coordinates the effort and timeline to ensure the CIA does not expire before the applicant has adequate time to review and sign the CCA.</p>
Step 4	<p>The host distributor/transmitter prepares and issues an upstream CCA/CCRA. Host distributor and transmitter (if applicable) have up to 45 days in total to complete this step.</p>
Step 5	<p>The distributor reviews the upstream CCA/CCRA, finalizes and issues a complete CCA to the applicant.</p>
Step 6	<p>The applicant reviews the complete CCA and seeks clarification from the distributor if required.</p>
Step 7	<p>The applicant decides whether to sign the CCA. If yes, proceed to step 8. If no, proceed to step 14.</p>
Step 8	<p>The applicant signs and submits the CCA and pays the estimated connection cost to the distributor.</p>
Step 9	<p>The distributor acknowledges receipt of the CCA and sends the executed CCA to the applicant.</p>
Step 10	<p>If an upstream CCA/CCRA is required, the distributor proceeds to</p>

	step 11. If not, proceed to step 13.
Step 11	The distributor signs upstream CCA/CCRA and issues required payment to the host distributor/transmitter.
Step 12	The host distributor/transmitter signs the upstream CCA/CCRA and sends the executed upstream CCA/CCRA to the distributor.
Step 13	Proceed to the build and energization stage.
Step 14	The applicant notifies the distributor of the decision not to proceed with the CCA.
Step 15	Upon receiving confirmation that the applicant is no longer proceeding with the CCA, the distributor will release the capacity previously allocated to the project and notify the host distributor/transmitter.
Step 16	The project ends.

## 6.2 Connection Cost Responsibility (CCR)

Connection cost responsibility is outlined in Chapter 3 and Appendix B of the DSC. The distributor shall clearly outline the connection cost responsibility in the CCA.

## 7. Build and Energization

Once the CCA is executed, the distributor assigns a project manager and arranges for a kick-off meeting with the applicant within 45 days. The applicant is responsible to provide any required information or documents to support the distributor’s engineering design review. This review shall be completed within 1 month after the distributor receives all the required information / documents. The applicant may only begin construction as agreed upon by the distributor. The Build and Energization process flowchart begins with the assignment of the distributor project manager at the conclusion of the CCA phase. The process flowchart is outlined in Figure 6: Build and Energization Process. The corresponding process steps for the distributor, host distributor, transmitter and applicant are detailed thereafter.

### 7.1 Overall Build and Energization Process

### Build and Energization Process

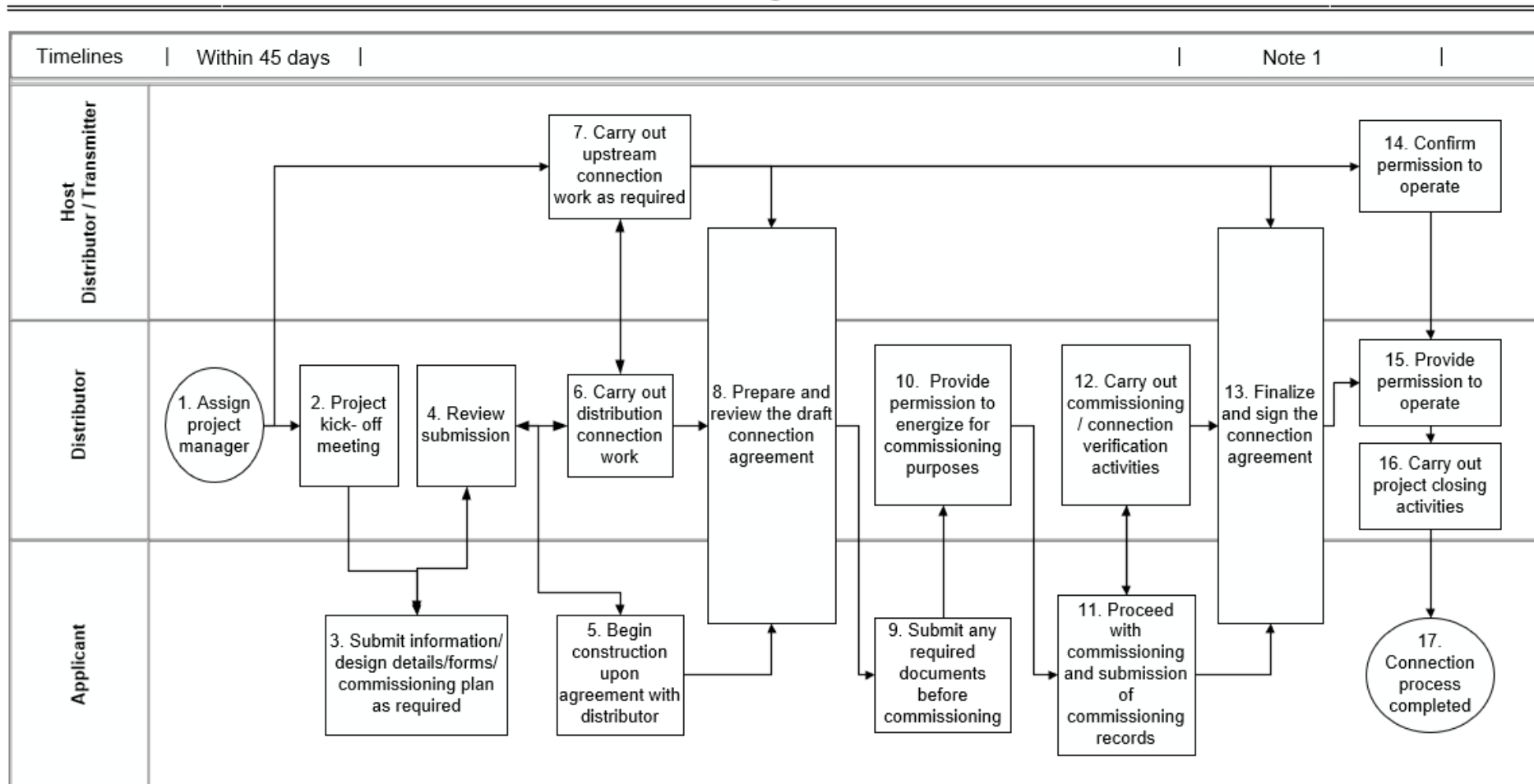

NOTE 1: Subject to the completion of commissioning and testing of the facility, a distributor shall connect the proposed facility within:  
 Small DER (a): 60 days when there is no distribution system reinforcement or expansion required to facilitate generator connection  
 Small DER (b): 180 days when a distribution system reinforcement or expansion is required to facilitate connection  
 Mid-sized and Large DER: Negotiated during plan commitment

Figure 6: Build and Energization Process

Step 1	The distributor assigns a project manager who will coordinate connection work with the applicant. If upstream connection work is required, the distributor’s project manager will coordinate connection work with the host distributor/transmitter.
Step 2	The distributor’s project manager will complete a project kick-off meeting with all parties involved to discuss facility design, single line diagram, protections and controls, cost estimates, commissioning requirements and the project schedule including target in-service date.
Step 3	<p>The applicant shall, at the distributor’s request, submit construction documents, including but not limited to the following:</p> <ul style="list-style-type: none"> <li>(a) Project details including single line diagrams (SLDs), proposed project schedule, and targeted in-service date. The targeted in-service date must be no later than five (5) years for water power projects or three (3) years for all other types of projects from the initial date of connection application, or in accordance with the timelines in an executed IESO contract.</li> <li>(b) Commissioning plan</li> <li>(c) Summary of testing results, including any certificates of inspection or other applicable authorizations or approvals certifying that any of the applicant’s new, modified or replacement facilities have passed the relevant tests and comply with all applicable instruments and standards.</li> </ul>
Step 4	Once the applicant receives any applicable permits and upon agreement with the distributor, the applicant begins construction.
Step 5	Once the applicant receives any applicable permits and upon agreement with the distributor, the applicant begins construction.
Step 6	The distributor carries out any connection work required and coordinates with the host distributor/transmitter if upstream work is required. The distributor proceeds to step 18
Step 7	The host distributor/transmitter carries out any upstream connection work (if required).
Step 8	The distributor prepares and discusses the draft connection agreement with the applicant. The applicant reviews the terms and conditions in the draft connection agreement and discusses any

	necessary changes with the distributor. If required, the distributor will work with the host distributor/transmitter to prepare the upstream connection agreement between the distributor and the host distributor/transmitter.
Step 9	The applicant submits any required documents for facility energization/commissioning, including the commissioning plan, to the distributor.
Step 10	The distributor reviews the documents required for commissioning, and upon approval, provides the applicant permission to energize for commissioning purposes.
Step 11	The applicant proceeds with commissioning of the DER. Upon completion, the applicant submits the commissioning records to the distributor.
Step 12	The distributor carries out commissioning/connection verification activities.
Step 13	The distributor coordinates with the applicant and finalize any operating parameters and the connection agreement. Both the distributor and the applicant will then sign the agreement. If required, the distributor will work with the host distributor/transmitter to finalize and sign the upstream connection agreement between the distributor and the host distributor/transmitter.
Step 14	If necessary, the distributor coordinates with the host distributor/transmitter to confirm the permission to operate required for step 15.
Step 15	<p>Upon confirming that the applicant has received all applicable permits, the distributor provides the applicant permission to operate when all connection work items have been completed, and all connection requirements have been satisfied. The distributor proceeds to step 16.</p> <p>If the applicant has not completed its portion of connection work items or executed all planned commissioning and verification activities, but the DER facility can operate without adversely affecting the reliability and safety of the distribution system, the distributor may grant a permission to operate. When doing so, the distributor shall provide the applicant with a list of the incomplete tasks. The distributor and the applicant must agree</p>



	on the terms and conditions for completing these tasks, including a timeline. During this agreed period, the applicant is responsible for finalizing the remaining tasks.
Step 16	The distributor carries out project closing activities as described under section 7.4.
Step 17	Connection process completed.

## 7.2 Commissioning

A distributor shall establish and maintain clear commissioning requirements and processes that are proportionate with the risks associated with projects of different sizes and characteristics. The distributor shall post general commissioning requirements and processes electronically on the distributor’s website. Subject to safety and reliability requirements, the distributor shall make best efforts to minimize commissioning costs for applicants, such as only carrying out field visit when needed.

When a distributor requires an applicant of a proposed DER facility to comply with a specific commissioning standard or technical document, the distributor shall periodically review the document to implement newer versions if available or to assess its continued applicability.

### 7.2.1 Simplified commissioning and verification

A distributor shall offer a simplified commissioning and verification process to small DERs that meet the distributor-specific criteria, such as, but not limited to, a nameplate rated capacity threshold. The simplified process is expected to reduce connection costs and timelines for a subset of small DERs.

When a distributor requires an applicant of a DER facility that meets the criteria for a simplified process to perform any commissioning and verification tasks, the distributor shall provide the applicant with a simplified commissioning and verification form. This form must be based on the simplified template in Appendix F and adhere to the requirements and expectations outlined therein.

## 7.3 Connection Agreement

A Connection Agreement between a distributor and an applicant outlines specific terms and conditions governing the connection to the distributor’s distribution system. Appendix E of the DSC provides forms of connection agreements for micro, small, and mid-size generation facilities.

Table 2: Other Potential Agreements

Agreement Name	Parties	Purpose
Construction Agreement (e.g. Connection Cost Agreement)	Distributor, Generator	Describes obligations of the distributor and the generator to complete connection, including terms of cost recovery.
Construction Agreement (e.g. Connection Cost Recovery Agreement)	Distributor, Transmitter)	<p><u>As specified in the Transmission System Code</u></p> <p>In the event a transmission system requires modifications to connect the generator, this document describes the obligations of the distributor and the transmitter to complete the connection, including terms of cost recovery.</p>
Conditions of Service	Distributor, Generator	In the event that the generator is also a load customer of the distributor, this document describes terms and applicable rates.
Additional Operations Agreement (if required) <sup>3</sup>	Distributor, Generator	<p><u>Within limits of permission under of the DSC</u></p> <p>Modifications as necessary to existing Connection Agreement to include provisions for safe and effective operation in presence of the generator on the distribution system.</p>

When a distributor and an applicant enter into a flexible hosting capacity arrangement, the distributor shall clearly outline in Schedule D of the connection agreement set out in Appendix E of the DSC for that size of generation facility all system conditions, operating requirements and/or contractual terms that will require the output or operation of the generation facility to be varied.

### 7.4 Project Completion

The distributor provides a connection cost report or connection cost true-up and processes potential deposit refund as described under the DSC section 6.2.18F. The

<sup>3</sup> Additional Operations Agreement(s) or Construction Agreement(s) may be required where other parties are affected by generation connection, e.g.: distributors.

distributor will also carry out a review to ensure all connection work items and requirements have been completed and closes the project accordingly.

If the distributor provides a permission to operate when the applicant has not completed its portion of connection work items or executed all planned commissioning and verification activities and the applicant does not meet the terms and conditions agreed to under the process step 15 of Figure 6, the distributor may revoke the permission to operate until the applicant fulfil the agreement.

Once the connection process is complete, the applicant operates and maintains the proposed DER.

## 8. Glossary

### ***Point of Common Coupling (PCC)***

The point where the distributor's distribution system ends, and the new DER's connection assets or the existing load customer's connection assets begin. This is equivalent to the DSC definition for Point of Supply. The PCC is shown in Figure 7: PCC vs PODC (Without Distributor-Owned Line Expansion) and Figure 8: PCC vs PODC (With New Distributor-Owned Line Expansion), in relation to assets owned by the distributor (Local Distribution Company, LDC) and the customer.

### ***Point of DER Connection (PODC)***

The point where the DER connects with the DER's connection assets as outlined in Figure 7 and Figure 8

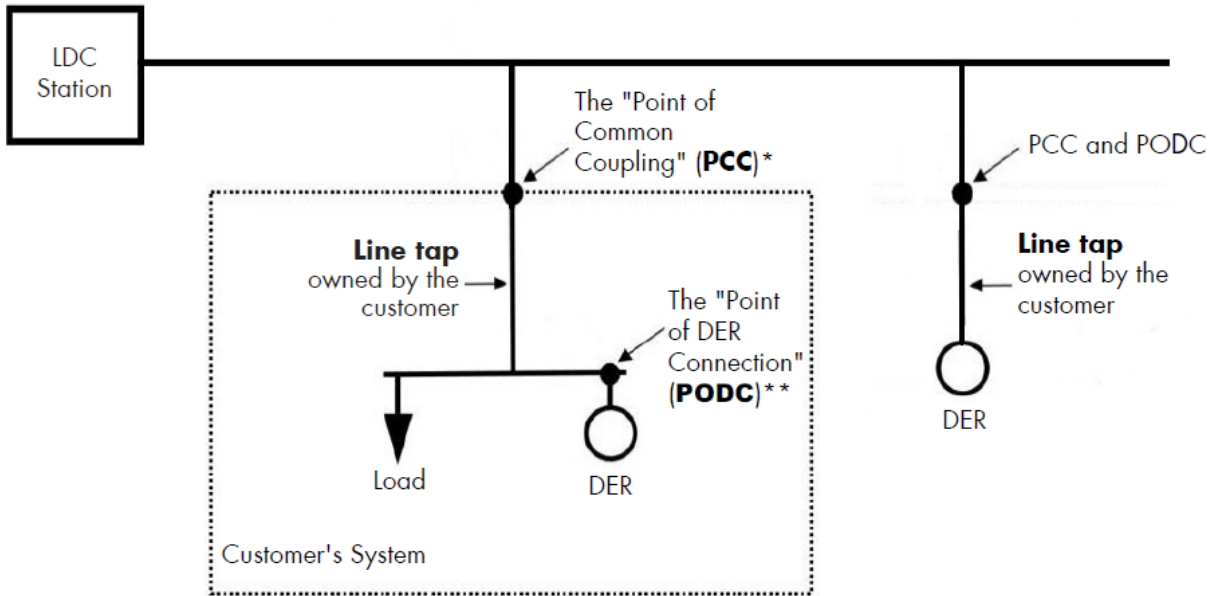

\*PCC: the point where the customer facility connects to the LDC owned system  
 \*\*PODC: the point where the DER unit(s)'s interconnection system connects the DER unit(s) to the DER facility.

Figure 7: PCC vs PODC (Without Distributor-Owned Line Expansion)

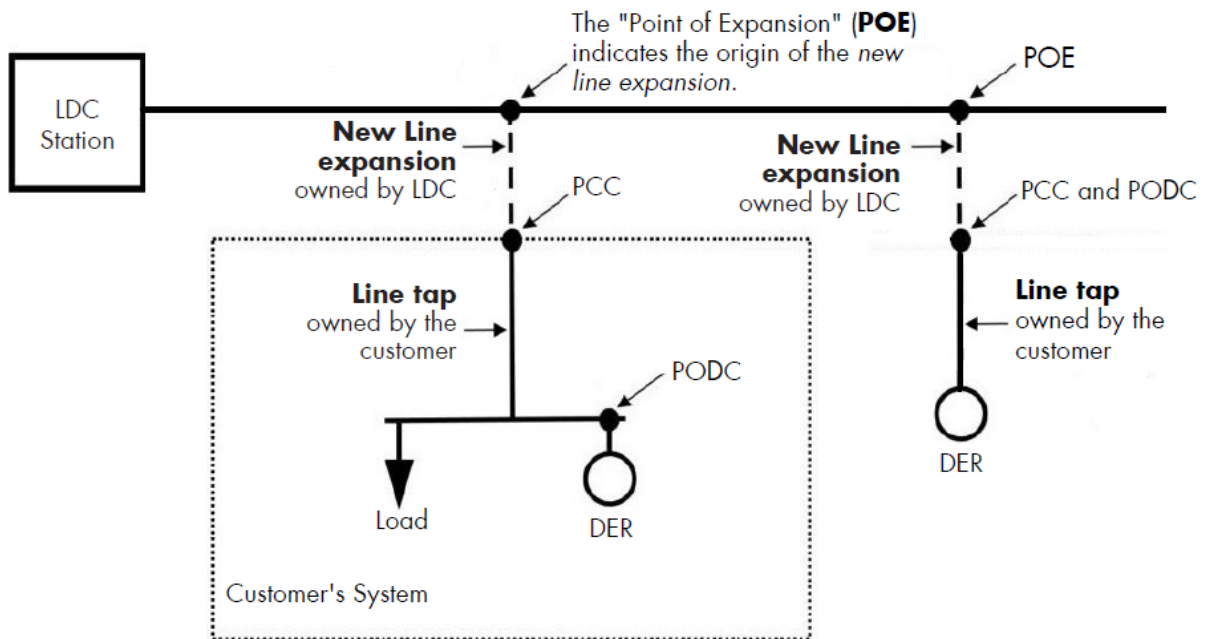

Figure 8: PCC vs PODC (With New Distributor-Owned Line Expansion)

## 9. Appendices

- A. Sample Protection Philosophy
- B. Single Line Diagrams
- C. Standardized Form Templates
  - i. Preliminary Consultation Information Request Template
  - ii. Preliminary Consultation Information Request Sample
  - iii. Preliminary Consultation Report Template
  - iv. Preliminary Consultation Report Sample
  - v. Connection Impact Assessment Application Template
  - vi. Connection Impact Assessment Application Instructions
  - vii. Connection Impact Assessment Application Sample
  - viii. Connection Impact Assessment Modification Guide
- D. DER Classification
- E. Simplified Connection Impact Assessment
- F. Simplified Commissioning and Verification Template

**Appendix A - Sample Protection Philosophy for Battery Energy Storage System**

## **Sample Protection Philosophy for Distributed Energy Resource Proponents Applying for Connection**

---

This document is a summary of a sample protection philosophy for non-exporting, inverter-based (NE/I) connections including storage, solar, and wind. The OEB intends it as a guide for applicants regarding the kinds of protections, and particularly the categories of protections, that distributors will require for connection.

This is one example of a protection philosophy that would meet the requirements for a complete protection philosophy for the purpose of a CIA application<sup>4</sup>. Other philosophies may also meet the standards. It provides guidance to a distributed energy resource (DER) proponent on good utility practice as it relates to protection requirements of non-exporting, inverter-based (NE/I) DERs. To form a protection scheme, all the elements for each category within any given protection philosophy are requirements.

This document is not an approval for connection. This information should help applicants file better and more complete applications for connection. An applicant will need to submit detailed protection settings after the utility has completed the impact assessment of the submitted connection application.

The standards and certification testing referenced in this document should be read as referring to the current versions of these standards at time of reading.

### **Sample Protection Philosophy for Non-exporting Inverter-based Sources**

Project Name:

Project ID#:

Project Type:

Capacity:

Connection feeder (optional):

In compliance with the technical interconnection requirements of the local distribution company for which this project will interconnect, the protection system of the connection will be designed to:

- Detect internal faults with the generator facility, downstream of the Point of Common Coupling (PCC), and automatically disconnect the NE/I source
- Detect external faults on the utility feeder and automatically disconnect the NE/I source
- Detect islanding conditions and disconnect the NE/I source
- Detect export of power from the NE/I source to the utility feeder and automatically disconnect the NE/I source

### **Internal Faults Within the Generator Facility**

The following protections are in place to protect against internal faults resulting from the NE/I source:

---

<sup>4</sup>The contents of this document, although intended as guidance, conform to the interconnection and approval requirements prevalent at the time of its issuance. At all times, the current versions of relevant codes and standards govern.

- **Multi-Function Relay**-At the PCC, a multi-function relay will be installed to monitor internal faults resulting from the NE/I source. The 52 Trip Breaker will trip if it detects the following:
  - 25 - Synchronization Check
  - 27 - Undervoltage
  - 59 - Overvoltage
  - 81O/U - Under and Over Frequency
  - ID -Active Anti-Islanding
- **Inverter Breakers** - Each inverter is equipped with an AC breaker at the output of the inverter providing additional overcurrent protection
- **Facility Overcurrent Protection** - All circuits within the facility are protected from both phase-to-phase and phase-to-ground faults by appropriate overcurrent protection devices. Fuses are sized to clear under fault conditions within the generator facility

### External Phase and Ground Faults in the Distribution System

The following protections are in place to protect against external faults resulting from the utility feeder:

- **Multi-Function Relay** - At the main utility service, prior to the first facility load, a multi-function relay will be installed to monitor faults from the utility feeder. The 52 Trip Breaker at the NE/I source PCC will trip under the following faults:
  - 27 - Undervoltage
  - 32R- Reverse Power
  - 50/51- Overcurrent
  - 59 - Overvoltage
  - 81O/U - Under and Over Frequency
  - 67 - Directional
- **Inverter Protection:** The inverters proposed for this project are certified to UL 1741, IEEE 1547, CSA C22.2 107.1-01 standards<sup>5</sup> and will behave accordingly.

### Anti-Islanding

- The Energy Resource Facility will operate in a grid following mode and will not operate islanded.
- **Anti-Islanding Inverters** -The NE/I source inverters contain both passive and active anti- islanding protection as required by IEEE 1547 and UL1741 SA. If the utility normal power supply is interrupted, the inverters detect the loss of power and disconnect.

### Reverse Power

- **Reverse Power Protection** - In addition to the multi-function relay at the utility supply monitoring reverse power (32R), the load is continually monitored to ensure the NE/I source discharge is below the consumption of the facility. This additionally protects

---

<sup>5</sup> All references to standards or testing certifications should be read as the most current version.



against power injection to the utility grid.

### **Directional Overcurrent**

- **Directional overcurrent protection** - Directional overcurrent relays are normally used on incoming line circuit breakers on buses which have two or more sources. They are connected to trip an incoming line breaker for fault current flow back into the source, so that a fault on one source is not fed by the other sources.

### **Special Comment Regarding Inverter Based Generation**

The inverters specified for this project have a limited fault current contribution.

- Because inverters are current-limited devices, unlike rotating generators, the fault current is very close to the maximum output current, limiting the fault current in the system to 120% -140% of FLA.

### **Breaker Failure Scheme (Facilities with an aggregate output > 500kW)**

In the event that 52-A fails to open when intertie protection relay calls for a trip, 52-B will instantaneously trip and lock out.

### **Reconnection**

Manual reconnection: There is no automatic reconnection scheme at this facility. A manual reconnection will only be executed when given permission by the respective controlling authority.

**OR**

Automatic reconnection scheme: Intertie protection relay will initiate automatic reconnection of DER only after a fault event has occurred on the utility feeder and not after a fault event within the DER facility. Stable voltage and frequency measurement within ranges and for time period stipulated in the technical interconnection requirements will be met prior to automatic reconnection. Internal faults will be distinguished from external faults by pickup of directional overcurrent 67/67N protection element looking into DER facility. This will ensure reconnection into facility fault is prohibited by blocking of automatic reconnection scheme for facility faults.

### **Open Phase Protection**

This project consists of multiple 1-phase inverters connecting to a 3-phase service or multiple 3-phase inverters connecting to a 3-phase service; therefore, open phase protection will be provided by 46 and/or 47 element(s) in the intertie protection relay to ensure the BESS maintains a balanced 3-phase output and detects loss of voltage in one or more phases and will trip the entire generating facility upon detection of such.

**OR**

Attached is a signed letter from the inverter manufacturer stating that a facility comprising of multiple inverters is capable of maintaining a balanced 3-phase output and will detect loss of voltage in one or more phases and will trip the entire

generating facility upon detection of such.

**Communications and Transfer Trip/DGEO (if applicable)**

Summarize communication systems and transfer trip/DGEO timing (if applicable).

**Table 1: Protection Summary Matrix**

Description	IEEE Device	Internal Faults	External Faults	Anti-Islanding	Reverse Power	Trips 52-A	Trips 52-B	Disables Inverters
Over-Voltage	59	X	X	X		X		X
Under-Voltage	27	X	X	X		X		X
Over-Frequency	81O	X	X	X		X		X
Under-Frequency	81U	X	X	X		X		X
Instantaneous Over-Current Phase	50	X	X			X		X
Timed Over-Current Phase	51	X	X			X		X
Reverse Power	32R			X	X	X		
Breaker Fail	50BF						X	
Active Anti-Islanding	IEEE 1547			X				X

**Table 2: Protection Elements**

Protection Element Function	Device#	Feeder Protection Relay/Shunt Trip	IEEE 1741 SA Inverter
Over-Voltage	59	X	Y
Under-Voltage	27	X	Y
Over-Frequency	81O	X	Y
Under-Frequency	81U	X	Y
Synchronization Check	25	X	Y
Reverse Power	32R	X	
Overcurrent	50/51	X	Y
Directional	67	X	
Active Anti-islanding	ID		X

X = Primary      Y = Secondary

**Appendix B - Sample Single Line Diagram**

Item Number	Information to Include
1	<p>The title block should include:</p> <ul style="list-style-type: none"> <li>• The legal name of the facility owner</li> <li>• Facility address/location</li> <li>• Project purpose</li> <li>• LDC assigned project ID</li> <li>• Revision history</li> </ul>
2	<ul style="list-style-type: none"> <li>• State utility’s distribution and transmission facility (station) name(s)</li> <li>• State the name of utility’s station feeder to which the generator is connected</li> <li>• State the nominal distribution supply voltage (eg. 44kV)</li> <li>• State the information for the upstream and downstream switches closest to the PCC (nomenclature, type, etc.)</li> </ul>
3	<ul style="list-style-type: none"> <li>• LDC to assign nomenclature for this switch.</li> </ul> <p>Note: initial submission can have the consultant/customer assigned nomenclature if a LDC designation is not yet available. Later, the customer is assigned a LDC designation, which should be added to the SLD and resubmitted to LDC before the SLD is considered finalized. The consultant/customer then has the option to replace the initial designation with LDC designation or keep both. Ensure the LDC designation is clearly marked to differentiate it from the consultant/customer designation (bolded, in brackets, etc). Item 3 has an example showing only LDC designation, while item 17 shows an alternate method that shows both designations. LDC only refers to the LDC designation when dealing with the customer. Example, when witnessing the switch used for work protection as per the LDC TIR. When submitting the new SLD with the changes, a higher revision number of the SLD should be used to track the changes. See SLD example.</p>
4	<ul style="list-style-type: none"> <li>• The Point of Common Coupling (PCC) is the point of demarcation between LDC and the DER. It is the point where the DER is to connect to LDC’s Distribution System. PCC demarcation point</li> <li>• LDC designated facility operating designation (NCXXXX)</li> <li>• If the nomenclature is not included, the SLD is considered incomplete.</li> </ul>
5	<ul style="list-style-type: none"> <li>• Fault indicators with directional functionality are required for each phase between the PCC and the first pole on the customer owned new line and should be visible from the PCC location.</li> </ul>
6	<ul style="list-style-type: none"> <li>• Provide the length(s), ownership, and size(s) of line(s) from PCC to the meter. This data is used for SSLA determination. The metering point is at the location of the CT’s and not the physical meter.</li> <li>• To comply with LDC TIR</li> <li>•</li> </ul>
8	<ul style="list-style-type: none"> <li>• State the number of CTs being used</li> <li>• State the CT ratios including both ratios if they are dual ratio</li> <li>• State the in-use CT ratio if dual ratio</li> <li>• State the ANSI/CSA CT accuracy class information (provide example on SLD after)</li> </ul>
9	<ul style="list-style-type: none"> <li>• Clearly identify existing and new facility if applicable</li> </ul>

Item Number	Information to Include
	<ul style="list-style-type: none"> <li>• If a new equipment (ex. transformer) is being replaced in an existing facility, it should be indicated</li> <li>• Ensure all existing generators or backup generators are shown</li> </ul>
10	<ul style="list-style-type: none"> <li>• LDC designation must be shown</li> <li>• Voltage rating</li> <li>• Current rating</li> <li>• Type of switch</li> <li>• Single/3 phase</li> <li>• Physically accessible to LDC</li> </ul> <p>Alternatively, switch information can be shown on SLD as per item number 14</p>
11	<p>Fuse information to include:</p> <ul style="list-style-type: none"> <li>• Fuse rating</li> <li>• Manufacturer make/model</li> <li>• Fuse type on the SLD</li> <li>• Example: S&amp;C SMD-1A 50E TCC153</li> </ul>
12	<p>Transformer Information to include:</p> <ul style="list-style-type: none"> <li>• Winding configuration</li> <li>• LDC designation</li> <li>• Manufacturer make/model</li> <li>• Rating</li> <li>• Ratio</li> <li>• Transformer ownership</li> </ul>
13	<ul style="list-style-type: none"> <li>• Please detail where the existing FIT/micro-FIT generator/meter are connected.</li> <li>• Include LDC ID</li> <li>• Show existing load</li> <li>• Capacity</li> <li>• Type</li> </ul> <p>For new generators:</p> <ul style="list-style-type: none"> <li>• Show the generator(s) connection(s) to the power transformer(s)</li> <li>• Show the operating nomenclature of the generator(s) (e.g. G1, G2, etc.)</li> <li>• State the nameplate capacity of the generator or individual generators, where there is more than one, in kVA / MVA. or kW /MW</li> <li>• For solar, state the size(s) and number of inverter(s)</li> <li>• State the operating power factor (PF)</li> <li>• State connection type (Wye, Delta, etc.) and indicate grounding</li> <li>• State whether the generator is induction or synchronous type.</li> </ul>
14	<p>This is an alternate way to item number 10 to show the information for a switch</p> <ul style="list-style-type: none"> <li>• LDC designation</li> <li>• Voltage rating</li> <li>• Current rating</li> <li>• Indicate which device is compliant with isolation device requirements</li> </ul>
15	<ul style="list-style-type: none"> <li>• To comply with LDC TIR</li> </ul>
16	<p>See item number 12</p>

Item Number	Information to Include
17	<ul style="list-style-type: none"> <li>• LDC designation</li> <li>• Manufacturer make/model</li> <li>• Current rating</li> <li>• Single/3 phase</li> </ul> <p>Note: initial submission can have the consultant/customer assigned nomenclature if a LDC designation is not yet available. Later, the customer is assigned a LDC designation, which should be added to the SLD and resubmitted to LDC before the SLD is considered finalized. The consultant/customer then has the option to replace the initial designation with LDC designation or keep both. Ensure the LDC designation is clearly marked to differentiate it from the consultant/customer designation (bolded, in brackets, etc). Item 3 has an example showing only LDC designation, while item 17 shows an alternate method that shows both designations. LDC only refers to the LDC designation when dealing with the customer. Example, when witnessing the switch used for work protection as per the LDC TIR. When submitting the new SLD with the changes, a higher revision number of the SLD should be used to track the changes. See SLD example.</p>
18	<ul style="list-style-type: none"> <li>• The Point of DER Connection (POC) is the point where DER unit(s)'s interconnection system connects the DER unit(s) to the DER facility.</li> <li>• Depending on the facility, it can be the same as the PCC</li> </ul>
19	<ul style="list-style-type: none"> <li>• Include LDC Project ID #</li> <li>• Inverter manufacturer make/model</li> <li>• MW rating</li> <li>• IEEE/ANSI protection elements need to be noted for the customer's inverters</li> <li>• Include CSA Certification</li> </ul>
20	<ul style="list-style-type: none"> <li>• Manufacture make/model</li> <li>• MWh rating</li> <li>• Include information for gross load billing where required</li> </ul>
21	<ul style="list-style-type: none"> <li>• Teleportation equipment make/model</li> <li>• Flow of information/signals</li> </ul>
22	<ul style="list-style-type: none"> <li>• Relay manufacturer make/model</li> <li>• ANSI Device numbers used</li> <li>• Flow of information signals</li> </ul>
23	Flow of signals between devices
24	<p>Other general information required:</p> <ul style="list-style-type: none"> <li>• SLD must be stamped and signed by a Registered Professional Engineer in the Province of Ontario</li> <li>• All information on the SLD must be legible, and of a reasonably sized font for ease of reading</li> <li>• The Connection Impact Assessment provides details regarding the type and configuration of isolation devices required.</li> <li>• The DER facility must comply with all applicable interconnection requirements specified in the "Distributed Generation Technical Interconnection Requirements Interconnections at Voltages 50kV and Below" (TIR).</li> </ul>



## Appendix C - Standardized Form Templates

To facilitate distributors uploading these documents to their website the following templates are posted on the OEB website at: <https://www.oeb.ca/regulatory-rules-and-documents/rules-codes-and-requirements/distribution-system-code-dsc>

- i. Preliminary Consultation Information Request Template
- ii. Preliminary Consultation Information Request Sample
- iii. Preliminary Consultation Report Template
- iv. Preliminary Consultation Report Sample
- v. Connection Impact Assessment Application Template
- vi. Connection Impact Assessment Application Instructions
- vii. Connection Impact Assessment Application Sample
- viii. Connection Impact Assessment Modification Guide



## Appendix D - DER Classification

Table 1 in Section 5.1 outlines the classification of DERs, primarily based on their nameplate rated capacity. This appendix provides further clarification on how capacity ratings are determined, particularly for sites with multiple DERs or derated equipment.

- **Site with multiple DERs:** The nameplate rated capacity for a site calculated as the sum of the AC nameplate rated capacities of all DERs if they are not connected to the same inverter. If these DERs share the same inverter, the nameplate rated capacity for the site is determined by the AC nameplate rated capacity of the inverter.
- **Site with derated equipment:** The distributor shall accept statically derated capacity, achieved through configured power rating control, instead of the nameplate rated capacity, as detailed in Section 5.1. Transformers do not affect the capacity rating of a DER facility.

## Appendix E - Simplified Connection Impact Assessment

This appendix outlines additional expectations and recommendations regarding the simplified CIA option.

### Application eligibility

A distributor may consider adopting the following nameplate capacity thresholds for the simplified CIA option. It is recommended that the distributor conduct a through analysis before establishing distributor-specific thresholds.

❖ Single-phase DER:

- > 10 kW and ≤ 30 kW

❖ Three-phase DER:

- Connecting to a supply feeder with a voltage less than 15 kV
  - > 10 kW and ≤ 50 kW
- Connecting to a supply feeder with a voltage of 15 kV or greater:
  - > 10 kW and ≤ 100 kW

If a distributor can offer simplified CIA to prospective DERs based on the listed thresholds for most, but not all, of its distribution system, it may still apply these thresholds. The distributor may post on the DER connection website a list of conditions or specific feeders where a DER may not be qualified for a simplified CIA, along with a general explanation, such as low load density or high DER concentration levels.

If the distributor-specific threshold(s) have lower nameplate capacity thresholds as those listed above (i.e. 30kW, 50kW, and 100kW), the distributor should provide a general explanation for the lower thresholds on its DER connection website. This allows transparency and supports potential future industry reviews of the simplified CIA process.

The distributor should provide the applicants with an opportunity to get a confirmation whether their proposed DER qualifies for a simplified CIA process. This confirmation can be obtained through the preliminary consultation process or through the CIA application screening.

### Application fee

A distributor is expected to charge an application fee proportionately reduced to reflect the lower costs associated with the time and materials required for a simplified CIA, as compared to the costs for a full CIA, for small DER thresholds.

The distributor should review the Handbook for Utility Rate Applications and relevant Filing Requirements<sup>6</sup> to determine whether a new specific service charge or a change to

---

<sup>6</sup> Filing Requirements for Electricity Distribution Rate Applications – 2023 Edition for 2024 Rate Applications, Chapter 2 Cost of Service, December 15, 2022

an existing charge requires the OEB’s approval. If applicable, the distributor must seek approval from the OEB when setting a standardized fee for a group of customers. The establishment of a specific service charge is excluded from the incentive rate-setting mechanism application process and is typically proposed in a distributor’s cost of service application.<sup>7</sup>

The distributor may consider establishing multiple tiers of simplified CIA options, each with different fee structures that reflect the actual costs to carry out a simplified CIA for these thresholds.

The distributor should provide clear and transparent fee information on its website. This is particularly important because:

- Due to distributor-specific system conditions, not all DERs within the simplified CIA thresholds may qualify for a simplified CIA.
- The distributor may need to inform the applicant of the need for additional studies or a full CIA, along with additional fees.

The total connection assessment fee should not exceed the fee for a full CIA for the same or similar thresholds.

Below is an example to illustrate multiple tiers of simplified CIA thresholds and the associated costs.

Nameplate Capacity Size	Simplified CIA Eligibility	Fee
1. Group size #1	Apply to all DERs within this group.	Fee info for this group.
2. Group size #2	Potentially. Confirmation is required.	Fee info for the simplified CIA option and fee info for the full CIA option (if required).
3. Group size #3	Potentially. Confirmation is required and the general eligibility exemptions are listed below [...]	Fee info for the simplified CIA option and fee info for the full CIA option (if required).
4. Group size #4	No	Fee info for the full CIA option.

### Timeline

Upon receipt of a complete application, a distributor must follow the existing requirements to provide the applicant with its assessment of the impact of the proposed generation facility, a detailed cost estimate of the proposed connection and an offer to connect. The recommended timeline is within 30 days. The distributor should aim to reduce assessment timeline for simplified CIA option.

<sup>7</sup> Filing Requirements for Electricity Distribution Rate Applications – 2023 Edition for 2024 Rate Applications, Chapter 3 Incentive Rate-Setting Applications, June 15, 2023

## Potential outcome

The outcome of a simplified CIA may result in a requirement for additional studies, a full CIA or an offer to connect. A distributor should clearly communicate the potential outcomes of this process. If additional studies or a full CIA is required, the distributor will promptly notify the applicant. The total fee and timeline for the connection assessment process should be equal to or less than the payment and timeline required for a normal CIA.

## Simplified CIA process

Below are high-level process steps for a distributor to consider before offering simplified CIA:

Step 1: Review the starting point thresholds outlined in the Application eligibility section and carry out assessment to determine distributor-specific thresholds for the simplified CIA option.

Step 2: Set the distributor-specific fee for a simplified CIA. The fee should be proportionately reduced to reflect the reduced costs associated with the time and materials required for a simplified CIA.

Step 3: Revise existing process and/or template as needed.

The distributor should follow the majority of the process steps outlined in DERCP Figure 4 for carrying out a simplified CIA. The process should be adjusted to integrate the following activities:

- a) The applicant is to obtain confirmation if the proposed DER is qualified for a simplified CIA.
- b) If additional studies or a full CIA are required, the distributor will notify the applicant, including any additional fees (if applicable). The distributor should provide the applicant with sufficient time to respond and confirm. The applicant should acknowledge the change, agree to proceed, and pay any additional fee, if required.

Step 4: Post simplified CIA information and documents on the DER website, such as:

- Simplified CIA nameplate capacity thresholds (including potential exemptions) and fees.
- Instruction on how to obtain a confirmation on whether a prospective DER is qualified for the simplified CIA option (e.g. through preliminary consultation process or CIA screening process).
- Any applicable forms / templates.

## Appendix F - Simplified Commissioning and Verification Template

### INTRODUCTION & REQUIREMENTS

This template assists distributors in streamlining the commissioning and verification processes and forms. The template contains general requirements, recommendations, and potential sections with examples for a simplified commissioning and verification form.

When a distributor requires an applicant of a small DER facility, which meets the distributor-specific criteria for a simplified commissioning and verification process (as discussed under Section 7.2.1), to perform any commissioning and verification tasks, the distributor must provide the applicant with a simplified commissioning and verification form. The distributor-specific form must be based on this template and adhere to the requirements and expectations outlined below, as well as those in the potential sections.

#### GENERAL REQUIREMENTS AND EXPECTATIONS

- A distributor **shall use plain language** to enable DER applicants to better understand the process and requirements. It will also facilitate meaningful dialogues with their DER consultant and the distributor and promote prompt responses related to commissioning submissions.
- A distributor **shall provide all necessary information** on the form and shall post the general form on the distributor's website. If a separate document is created for any section, the distributor must include a high-level summary and a link to the document. The requirement to simplify and use plain language applies to all additional documents as well.
- A distributor **shall be very specific** in its requirements for commissioning and verification tests. When a distributor refers to a certain standard requirement, the distributor must identify clearly the specific section in the standard.
- A distributor **shall not include** in the form any potential commissioning and verification **tests that are not applicable** to the proposed DER facility.
- The distributor must **aim to keep** the references and standard requirements **up to date**.

A distributor has the discretion to customize all potential sections below. However, some sections are mandatory. When a distributor chooses to include a particular section, the distributor must follow the general requirements outlined in the section.

## POTENTIAL SECTIONS TO BE INCLUDED IN THE SIMPLIFIED FORM

Below are potential sections a distributor may include in a simplified commissioning and verification form. Instructions for distributors are provided under the 'Instruction' headings and within the square brackets. Within each potential section, this template provides one or more examples to illustrate the type of information that could be included in the simplified form.

### 1. Applicability

Instruction: This section is **mandatory**. A distributor shall clearly define the criteria for the simplified commissioning and verification route under this section.

Please note that one of the general requirements is that a distributor must not include any commissioning and verification tasks that are not applicable to the proposed DER facility in the simplified form. Therefore, if a distributor creates a simplified form specific to a DER technology/type, they should only include relevant commissioning and verification tasks for that particular DER technology/type.

Example:

The simplified commissioning & verification form is applicable to a proposed DER facility that meets the following criteria:

- a) [Provide distributor-specific nameplate rated capacity thresholds]
- b) [Include any other potential criteria]

### 2. Process requirements

Instruction: This is a **mandatory** section. A distributor shall list all important process requirements, including information on what to expect after the commissioning process is completed.

- If there are potential additional costs to the applicant, such as charges for extra visits by the distributor if the applicant has not met the requirements before a certain commissioning task, please provide this information upfront under this section.
- If a distributor needs to review the results of a specific commissioning or verification task before the applicant can proceed with the remaining tasks, the distributor must clearly indicate this requirement in this section. As per the requirement under section 7.2, the distributor must make best efforts to minimize commissioning costs for applicants, subject to safety and reliability requirements. Normally, an applicant can carry out all commissioning and verification tasks for a simple DER system on the same date.
- A distributor will provide contact information in case applicants have any questions regarding the process requirements. The contact information should include name, title, phone number, and email address.

Examples of important process requirements:

- a) Before installing equipment and commencing testing of the facility, an applicant must [\[include the requirements here\]](#).
- b) The distributor will review the commissioning plan and generally respond to its acceptability within [\[#\]](#) days. To ensure a timely review, the applicant should be prepared to respond to any questions and inquiries promptly.
- c) The distributor has the right to witness the commissioning and testing of the connection of DER facilities. The applicant shall notify the distributor no later than [\[#\]](#) days prior to scheduled commissioning tests to enable the distributor to witness the commissioning tests.
- d) Important commissioning sections or materials [\[identify what they are here\]](#) must be signed by [\[select between a Professional Engineer \(P.Eng\) registered in Ontario and a licensed electrical contractor\]](#).
- e) The commissioning report shall be submitted for approval before the operation of the DER facility.
- f) Summary of testing results and certificates must be kept on file for a minimum period of [\[#\]](#) years by the applicant.
- g) In situations where site modifications [\[identify only modifications that need further discussion\]](#) are required, the applicant must notify the distributor to discuss the next steps.
- h) It is the applicant’s responsibility to ensure that all requirements are met. Additional requirements may be necessary to address unique situations, and the applicant will be advised of any additional requirements at the appropriate assessment stage.
- i) Upon completion of the commissioning steps, the distributor will initiate discussions regarding the connection agreement.

### 3. Project Information

Instruction: A distributor may consider asking applicants to provide project information in the form.

Example of information table:

General project and site details	
Project number	
Project address	
Project name	
Nameplate rated capacity (kW/kVA/PF)	
Export rated capacity (kW/kVA/PF)	
Planned in-service date	
Connecting station and feeder	
Number of electricity generating or storage device/inverters	
Manufacturer	

Generator/Inverter model number, quantity, and hardware certification			
1.		5.	
2.		6.	
3.		7.	
4.		8.	
Commissioning contact information			
Applicant name			
Applicant contact			
<ul style="list-style-type: none"> <li>• Name</li> <li>• Title</li> <li>• Date</li> <li>• Phone number</li> <li>• Email</li> </ul>			
			License No.
Design engineer			
Commissioning agent [identify engineer or licensed electrical contractor]			
Notes:			

#### 4. Commissioning and verification plan

Instruction: A distributor will inform the applicant of what information is to be included in the commissioning plan with instructions on how to submit to the distributor for approval.

Examples of potential information:

- a) Planned commissioning date:
- b) Milestone description

Please describe all commissioning and verification tasks the applicant plans to execute on the commissioning date.

If the applicant plans to have multiple commissioning dates with different milestones, the applicant is to include a milestone description for each commissioning date using the format below.

Milestone #:

Goal:

Commissioning date:

Tasks:

- c) [Include other potential items]



d) Signature from the commissioning agent [identify engineer or licensed electrical contractor]

Name: \_\_\_\_\_

Date: \_\_\_\_\_

Signature: \_\_\_\_\_

## 5. Checklist prior to the main commissioning and verification tasks

Instruction: This section is a **mandatory** section when a distributor requires an applicant to carry out any checks or verifications prior to the main commissioning and verification tasks.

A distributor can also use this section to inform the applicant about the specific checks it plans to conduct.

Example of a potential checklist an applicant may need to carry out:

The commissioning agent [identify engineer or licensed electrical contractor] is to carry out the following checks prior to conducting the main commissioning and verification tasks.

	<b>Results</b> (Yes/No)	<b>Initials</b>	<b>Comments</b>
Conductors are per the single-line diagram (SLD) (type, size and length)			
Fusing is installed as per SLD and protection scheme			
All switches & devices labeled for proper identification			
Nameplate values on the equipment are correct			
[Include other potential items as applicable]			

## 6. Commissioning and verification tasks

Instruction: This is a **mandatory** section. Under this section, a distributor shall list the required commissioning and verification tasks. A distributor must be very specific in its requirements and describe the requirements well.

Examples of potential tests:

[The following examples show how a distributor can be specific about certain commissioning and verification requirements].

Example 1: Cease to Energize

i. Turn off utility-size disconnect switch

Verification	Yes/No	Initials	Date	Notes
Did the DER facility indicate a loss of the utility grid?				
After a loss of the utility grid, is there voltage on the output of the DER facility?				
Did the DER facility shut down as required?				

ii. Turn on utility-size disconnect switch

Verification	Yes/No	Initials	Date	Notes
Did the DER facility turn back on upon reconnection with the utility grid?				
Did the DER facility wait the requisite 300s before returning to normal operation?				
Did the DER facility return to its normal operating state?				

Example 2: Steady-state parameters

The steady-state parameters listed in the table below must be monitored and recorded for a minimum of 5 minutes at the point of supply both prior to energization of the DER facility, and then another minimum 5 minutes while the DER facility is operating.

Parameter	Reference	Results	Notes
Voltage variations at the point of supply are limited to +/- 6% of the normal voltage			
Frequency is operating in the range of 59.3Hz to 60.5Hz			
Maximum output capacity requirement [Clearly identify the net export or zero export requirement] is met			
[Provide any other parameters]			

Example 3: Equipment Based Protection & Control

Commissioning agent [identify engineer or licensed electrical contractor] to review generator/inverter certificates and generator/inverter manufacturer production test reports in order to fulfill the following items.

Items to be verified	Standards/References	Results	Notes
Interface protection of the facility ceases to energize under the following conditions: <ul style="list-style-type: none"> <li>• Internal faults at the facility</li> <li>• External faults on the distributor's distribution system</li> </ul>			
Under-voltage protection is functioning Over-voltage protection is functioning			
Under-frequency protection is functioning Over-frequency protection is functioning			

## 7. Deficiency and resolution

**Instruction:** A distributor may ask the applicant to identify any potential deficiencies as well as the proposed resolutions under this section.

**Example:**

Please use the table below to document if the facility doesn't meet certain utility requirements, such as the kVA requirement.

Any operating/design deficiencies should be corrected before concluding commissioning and verification tasks and before submitting the required commissioning materials to the distributor.

Item	Deficiency	Resolution

## 8. Required supplementary document

**Instruction:** If there is a need to provide a distributor with supplementary document(s), a distributor shall identify the need under this section.

**Example:**

Please provide the following document(s) for review upon the completion of the commissioning and verification tasks.

Document	Notes

[Identify the document(s) here]	

## 9. Commissioning and verification signatures

**Instruction:** When a distributor asks for signatures, the distributor shall be clear about what the applicant and the commissioning agent are signing off on.

**Example:**

By signing this section, the applicant and the commissioning agent [identify engineer or licensed electrical contractor] acknowledge that all required commissioning and verifications tasks specified in this form have been completed.

The commissioning agent [identify engineer or licensed electrical contractor] also acknowledges that the facility meets the following connection requirements:

- a) [List the requirements that the commissioning agent is signing off on. The distributor must be as specific as possible. General wording, such as ‘minimum standard requirements’ is not sufficient].

Applicant	Name:	
	Signature:	
	Date (dd/mm/yyyy):	
Commissioning agent [identify engineer or licensed electrical contractor]	Name:	
	Signature:	
	Date (dd/mm/yyyy):	
	Licence number and seal (if applicable):	

## 10. Commissioning and verification report

**Instruction:** A distributor shall inform the applicant about the contents required in a commissioning report under this section.

A distributor shall clearly indicate what type of test results, if required, the distributor is expecting to ensure the correct commissioning equipment is being used, e.g. time intervals, resolution on data, plots, and graphs.

**Example:**

This section outlines the required items to be included in a commissioning report.

- Commissioning and verification tables under the “Commissioning and verification tasks” section with all information provided, including test results, dates, initials, and notes.
- Information under the deficiency and resolution section
- The required supplementary document(s)
- Commissioning and verification signatures
- [\[Include other potential items as applicable\]](#)

## 11. Submission checklist

Instruction: A distributor shall specify the required document(s) an applicant must submit to conclude the commissioning & verification process.

Example:

Please ensure the following items are completed and included in the submission to the distributor. The applicant will not proceed to the next connection step [\[be specific about what the next step would be\]](#) if any of these items is omitted or incomplete.

Item	Document
1.	Commissioning report
2.	Required supplementary document
3.	Commissioning and verification signatures
4.	<a href="#">[Include any other items as needed]</a>

## 12. References

Instruction: A distributor should identify the applicable references and provide links to those under this section.

Ideally, a distributor should clearly point out the applicable sections in these references.

Example:

The requirements in this package are primarily from the following sources:

[\[List references and provide links to those\]](#)